

seesky **luz**®



New generation of panoramic, sliding and fixed roofs





C3 Systems is very committed to its team, customers, the region and the environment. We work every year with the aim of identifying and proposing actions that contribute to sustainable, efficient and balanced economic growth. Therefore, we pay attention to the appropriate use of raw materials, conserve natural resources by promoting their responsible use, ensuring their supply and conducting studies to improve and identify new opportunities for economic growth. In addition, we develop innovative environmental products and ensure the protection of people's health and quality of life.

Look closely at the present you are building, because it must resemble the future you dream up.

~Alice Walker~

PANORAMIC SLIDING ROOF



Seesky LUZ is the latest generation of sliding panoramic, framed and fixed roofs. It is a modular and versatile system where all three variants can be combined. It also integrates perfectly with the **Seeglass** and **Habitat** product ranges to create unique spaces. Choose your way of looking at the horizon and create a new, unique space full of light.

The main feature of the **panoramic sliding roof** is the non-existent frame profile and the invisible guide rail of the glass panels, which makes it the most promising roof on the market.

The **panoramic sliding roof** is a system with a strong and long-lasting aluminium structure.

Seesky LUZ sliding roof + sliding glass wall Seeglass Habitat SOL veranda awning

A solution with an innovative and efficient design that, combined with the latest building technology, represents one of the most advanced roofs in the sector.

Thanks to the mobile panel option, the temperature of the room can be regulated to provide greater comfort and enjoyment 365 days a year. The high-quality materials together with the large dimensions of the system offer a robust, safe and powerful solution with a distinctive design with straight lines and a harmonious front.

With the **panoramic sliding roof** you can transform your house, terrace or restaurant into a small glass palace.



FIXED ROOF



The **roof with fixed glass panels** is the optimal solution for high thermal and sound insulation.

It is the best alternative to traditional roofs to protect the house in a safe way and is a great option for internal courtyards, verandas, terraces or penthouses.

Perfect for designing roofs with lots of light thanks to the minimal number of profiles that give the space great transparency and visibility.

FRAMED SLIDING ROOF

For design lovers, **Seesky LUZ** also offers a **motorised mobile version of the roof with framed panels**.

Available in 5+5 laminated glass or 16 mm double glazing, it is the right roof for every project variation.

With any **Seesky LUZ** variant, you can expand your space and feel comfortable in any area all year round - and without any construction work, with a high-quality finish and a long service life.





ADVANTAGES OF THE SYSTEM

- Decide for yourself how you would like to view the horizon: **panoramic sliding, framed sliding** or **fixed**
- Integrates perfectly with **Seeglass** and **Habitat**
- Innovative architecture through slim design
- Increased energy efficiency and watertightness
- Daylight optimisation
- Combined with each other, any of the three variants in the same structure
- Recommended for restaurants, terraces, gardens or verandas
- The perfect solution for everyday use and enjoyment 365 days a year
- Increase the living possibilities in your home and create new spaces
- A functional, helpful and practicable system

ADJUSTMENTS

Seesky LUZ is a versatile system that can be made to measure. There are various configuration options depending on the type of location and the mounting points of the system.

In addition, **Seesky LUZ** is a modular system that can be perfectly combined and integrated with the three roof types (**mobile panoramic, framed roof and fixed**). Incorporates a design of your choice into the structure to create a very personal living space that satisfies your needs.



Combined panoramic sliding roof and framing sliding roof **Seesky LUZ**

Product



COMMON FEATURES OF THE THREE VARIANTS

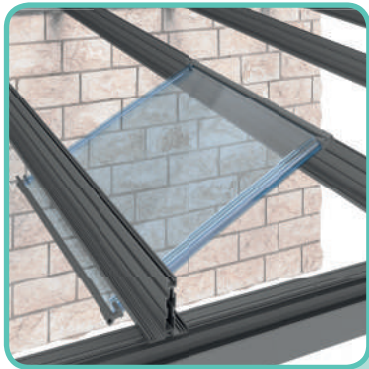

EASY AND COMFORTABLE INSTALLATION FROM INSIDE THE SYSTEM:

The assembly of the panels is carried out from inside and below the system thus achieving a safer installation.

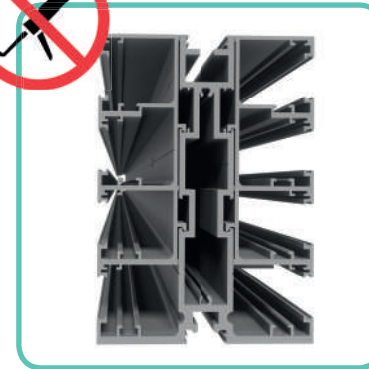

THE SYSTEM DOES NOT REQUIRE SEALING:

The system is designed in such a way that no sealing between profiles is required.



STRAIGHT-LINED ARCHITECTURAL DESIGN:

The attractive straight-lined design of Seesky LUZ and its imposing front of more than 250mm gives it great elegance, modernity and minimalism.



POSSIBILITY TO INCORPORATE LAMINATED GLASS PANEL, CAMERA 16mm OR SANDWICH PANEL 52mm:

Choose between 5+5mm laminated glass panel, 16mm laminated glass or 52mm sandwich panel for greater thermal and acoustic insulation.

CHARACTERISTICS OF PANORAMIC ROOFS

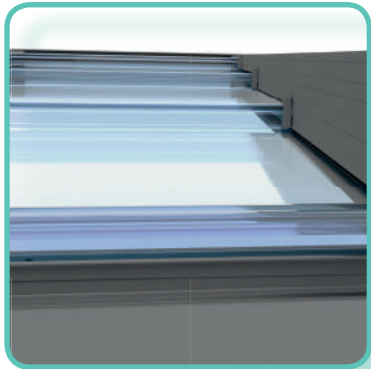

ABSENCE OF FRAMED PANEL:
By eliminating the metal crossover profiles in the **frameless sliding roof**, the system gains in harmony and gives you an unobstructed view.

CHARACTERISTICS OF FIXED ROOFS

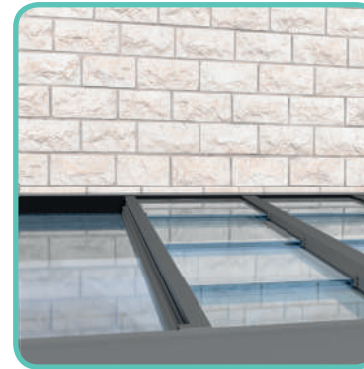

COVERS LARGE DIMENSIONS:
With the fixed variant of Seesky LUZ you can cover large dimensions to create the space you have always wanted. Laminated glass is up to 4 metres long compared to 3 metres for laminated glass. You have the option of installing a 52 mm sandwich panel covering up to 6.5 metres in length.

CHARACTERISTICS OF MOBILE ROOFS

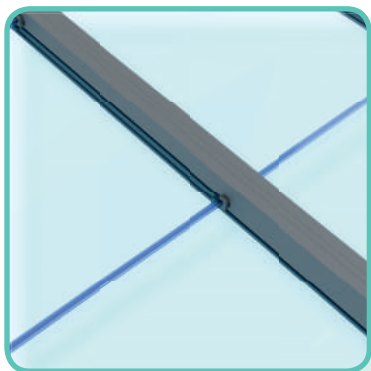

HIDDEN GUIDE:
The advantage of the glass panels of the movable ceilings is that their transmission is concealed and integrated in the system's own rails.

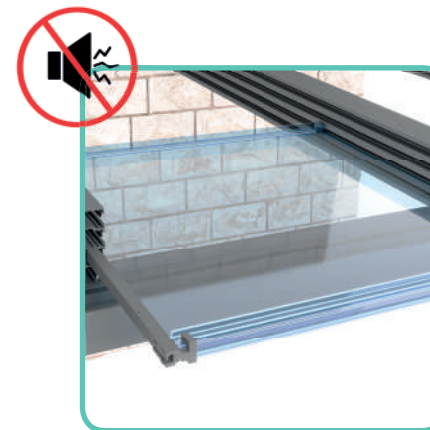

LIGHT AND SOFT SLIDING IN MOBILE SYSTEMS:
The traction on the sliding roofs is achieved without bearings. This gives a longer service life and low maintenance.

TECHNICAL DETAILS

	PANORAMIC SLIDING ROOF	FRAMED SLIDING ROOF		FIXED GLAZED ROOF		
	Laminated glass 5+5 mm	Laminated glass 5+5 mm	Chamber 3+3/6/4T*	Laminated glass 5+5 mm	Chamber 3+3/6/4T*	Sandwich Panel 52 mm
A Max. Panel width	1200 mm					
L Max. Panel length	1300 mm			4000 mm	3000 mm	6500 mm
S Maximum Exit	6500 mm					

*Tempered glass.

PANELS PER LANE				
Panels	2	3	4	5
Opening	50%	66%	75%	80%

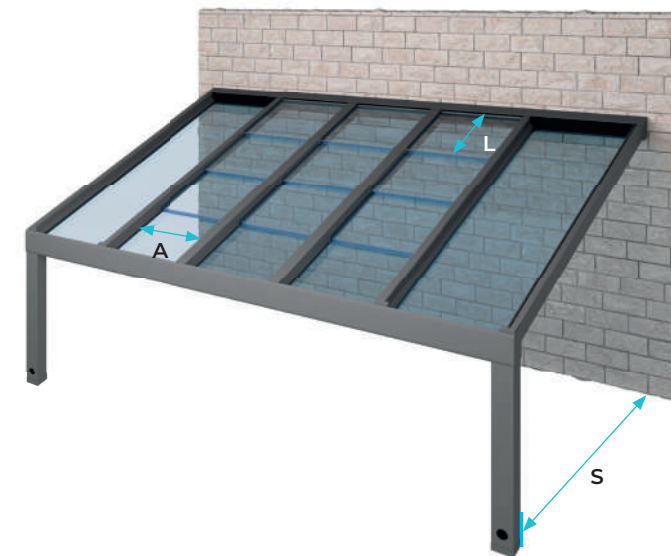

DISTANCE BETWEEN PILARS STANDARD BEAM
No Seeglass enclosure
5000 mm.**

**Without snow load.

DISTANCE BETWEEN PILARS REINFORCED BEAM
No Seeglass enclosure
6000 mm.**
With Seeglass enclosure
4500 mm.**

SECTIONS

1 WALL CONECTION SECTION 2, 3, 4 LANES

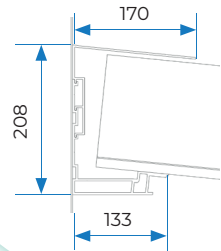

2 5-LANE COVER SECTION

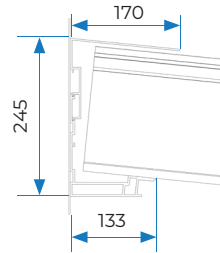

3 GUTTER SECTION + STD BEAM

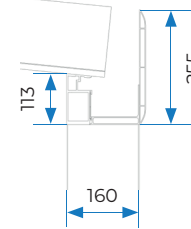

4 GUTTER + REINFORCED BEAM SECTION

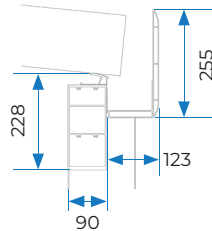

5 CENTRAL GUIDE SECTION MOBILE PANEL

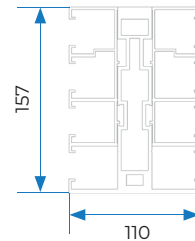

6 SECTION CENTRAL GUIDE 5TH RAIL MOBILE PANEL

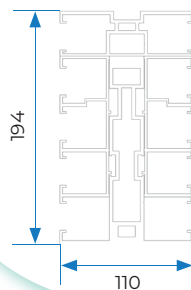

7 SIDE GUIDE SECTION FIXED PANEL

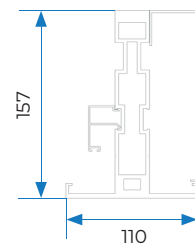

A -SUPPORT TYPE

- Adjustable
- Reinforced adjustable

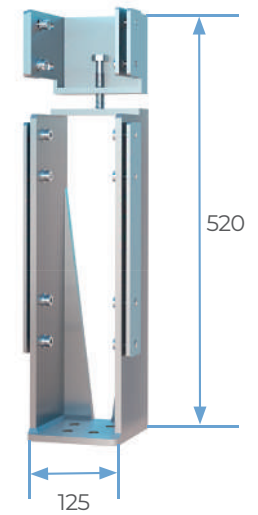

Reinforced adjustable support

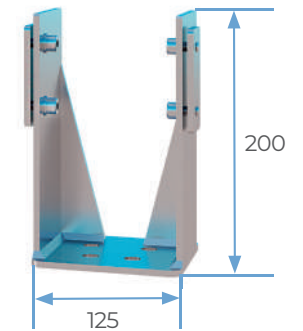

Adjustable support

DETAILS OF SUPPORTS AND CHANNELLING

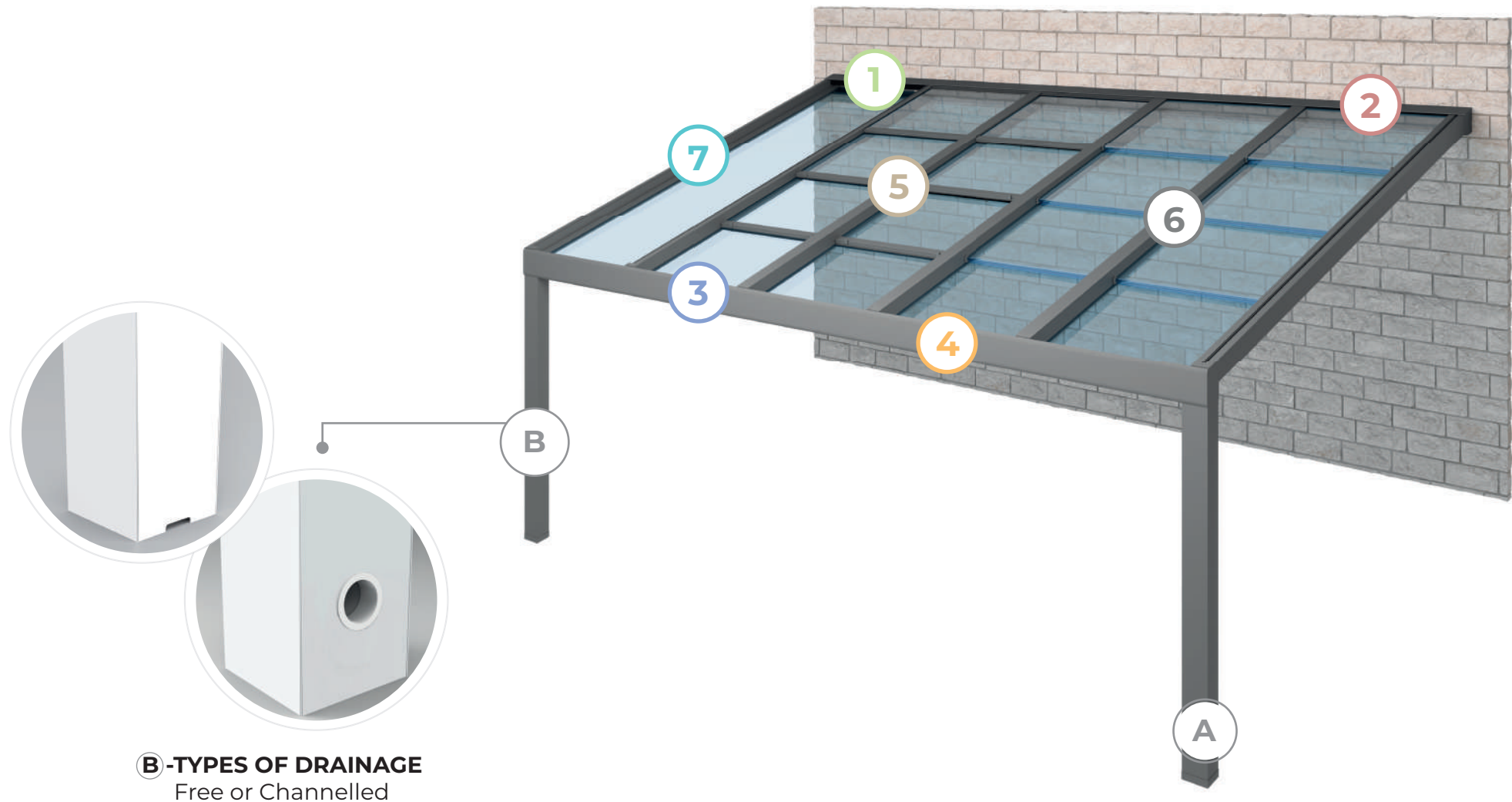

B-TYPES OF DRAINAGE
Free or Channelled



AUTOMATION

With **Nice's** bidirectional interface for smart home control, the Seesky LUZ sliding/fixed roofs offers the possibility of unifying home automation controls so that you can create the ideal environment in your home wherever you are. Thanks to the home automation integrated into the available options of the pergola, it is possible to optimize the use of energy to the maximum. Live a unique experience where comfort and well-being become the protagonists. The quality of C3 Systems in a highly sustainable and efficient system.

You can independently control each room. Going to an ecofriendly way to improve consumption in terms of ventilation, air conditioning and heating...

Create bespoke outdoor scenarios: programing the lighting, regulating the temperature of the room by opening or closing the slats, activate the temperature sensor... All this and much more in a single click.

Smart spaces for smart people. An innovative system designed for you.

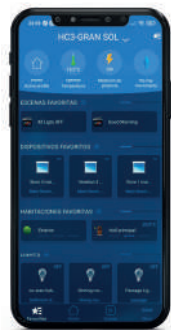

Nice





LIGHTING

The lighting LED is integrated into the roof in two types of formats:

- LED light in beam.
- Perimeter LED light.

Also, there are two kinds of color options:

- White 3000K/4000K
- RGB

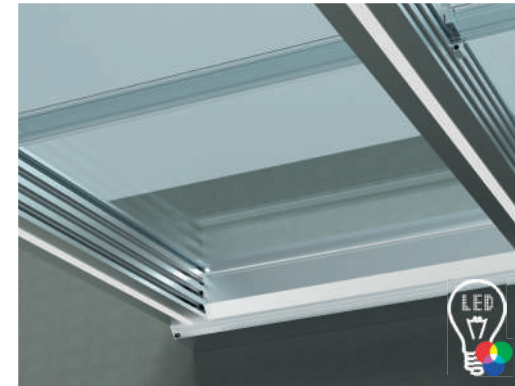

CLIMATIC SENSOR

Thanks to this unique sensor, the roofs adapts to weather conditions that may occur unexpectedly.

This automation of the **seesky-luz** sliding/fixed roofs allows you to deal with any inclement weather without worrying about activating the different devices.

In addition, it can be configured according to the most common weather conditions in the environment.



SYSTEM COMBINATION

seeglass® habitat®

Seesky-luz combined with glass enclosure systems **Seeglass-One-Sub-Run** that integrate perfectly with the roof structure. By not presenting vertical profiles that obstruct the outside view, we continue with one of our premises: To offer the widest view of the surroundings in the sector.

On fixed/mobile roofs **Seesky-luz**, **Habitat** solar protection systems can also be integrated. These provide greater comfort to the room while protecting us from sunlight, wind, insects or any other disturbing element that may intrude.

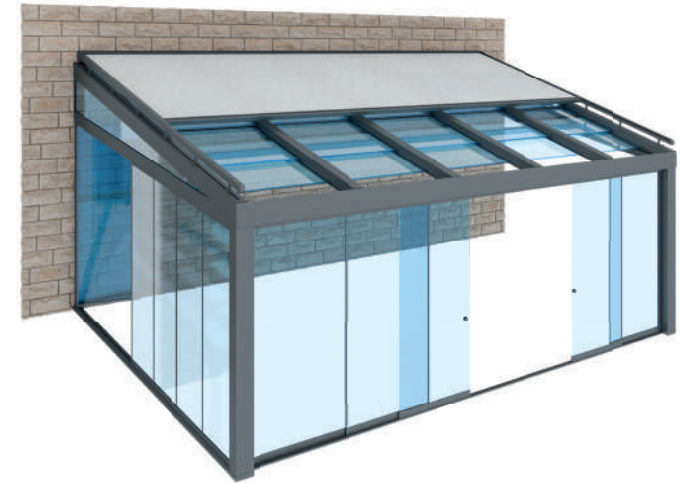

SPECIAL CONFIGURATIONS

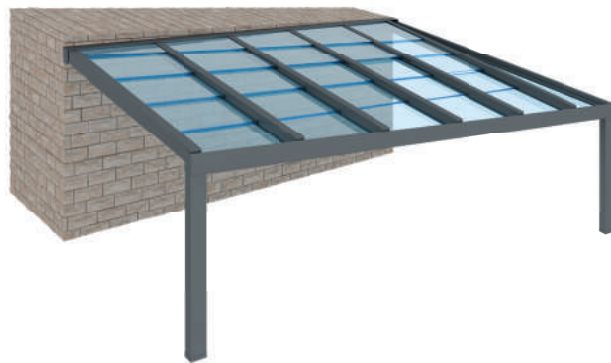

Seesky LUZ roof structure with lateral overhang

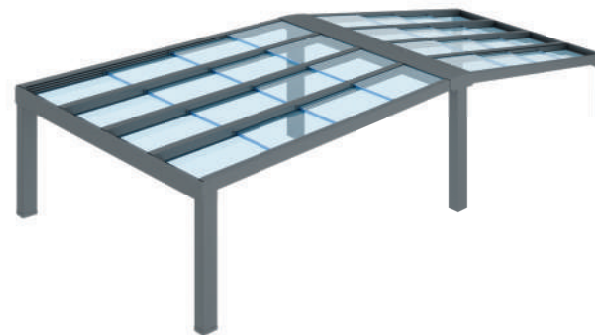

Seesky LUZ roof structure with gable roof

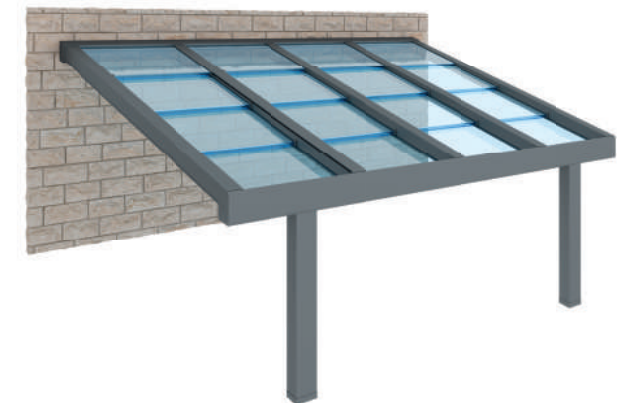

Seesky LUZ roof structure with pillar displaced inwards

Seesky-luz is available in all RAL colours, textured and matt. Visit our website to see our wide range of colours.



The aluminium profiles used to produce these articles meet the following requirements.

LEGATIONS

They are extruded in compliance with the UNE EN 12020-1 Standard.

They correspond to extruded aluminium alloy 6063 and heat treatment T5

They comply with the composition characteristics, according to the requirements established in the UNE-EN 573-3 Standard.

They comply with the dimensional tolerances, as specified in the UNE-EN 755-2 Standard 3.

These comply with the dimensional tolerances specified in the UNE-EN 755-2 standard.

LACQUERED SURFACE TREATMENT

Lacquered profiles are treated in facilities authorised to use the QUALICOAT Quality Mark for the PAINTING, LACQUERING and POWDER COATING OF ALUMINIUM FOR ARCHITECTURE, in compliance with the specifications of the QUALICOAT Quality Mark Guidelines.

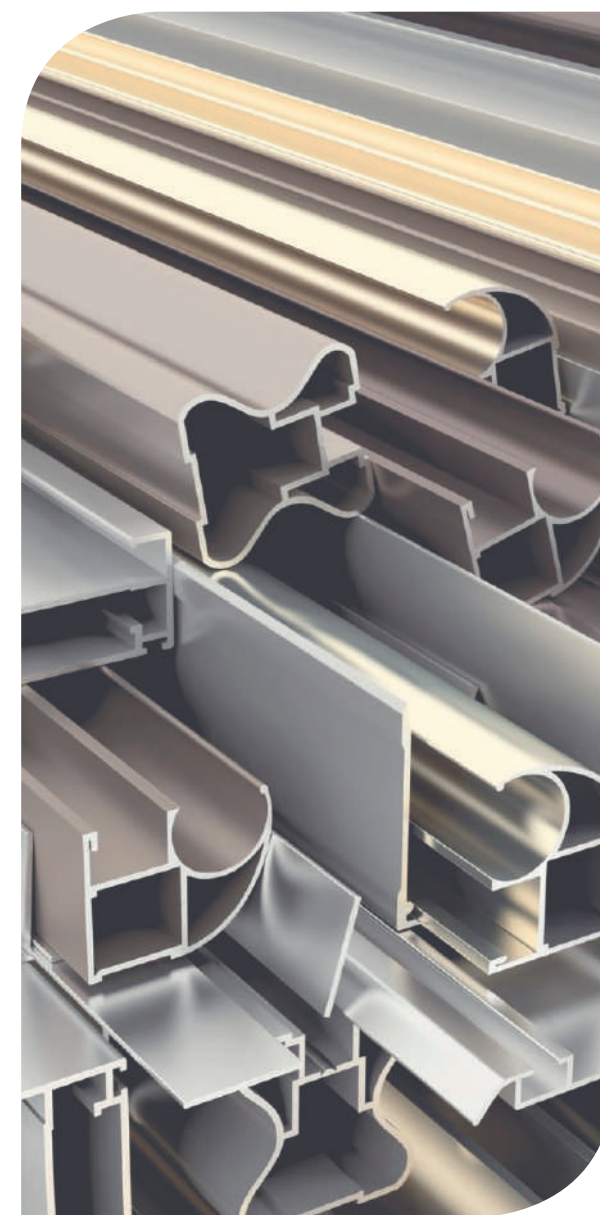

Why we should use aluminium for the windows of the future?

BECAUSE OF ITS ENVIRONMENTAL BENEFITS

It is the only material for windows that is 100% recyclable and can be used again and again.

It is the only material that is 100% sustainable and effectively recyclable. This is evidenced by the high price of its scrap metal content. The mineral from which it is made is available in virtually unlimited quantities

It is the only material that supports a 100% recycling economy.







Certifications

APPROVALS AND TESTS

Seesky-LUZ has the approved laboratory test certificates issued by the relevant certification bodies as defined by national and international legal regulations.

This certification gives you the certainty that with the products of C3 Systems, S.L. you are purchasing a quality product with all the necessary guarantees.

HIGHEST QUALIFICATION IN THE TEST*		
		
Wind-strength UNE EN 1932:2014 CLASS 6 - 100 km/h	Watertightness UNE EN 14963:2007 210 l/m ² (hour)	Snow load UNE EN 12833 120 kg/m ²
 *Tests performed after maximum measurements (6500x4800x2630mm.)		



Guarantee of the manufacturing quality and safety of the products of manufacturers from the metal sector, including metal constructions.



CE Marking

All our systems are approved by an official laboratory and meet the requirements of the European Commission to carry the CE mark. We have all the tests and certificates that comply with this regulation and we have a computer tool that makes it easy for the workshop to obtain this seal.



5 years warranty*

Seesky LUZ has 5 years for every component and 3 years for electrical components.

* (To see warranty in detail, please download the general conditions of sale in the customer area of the website).

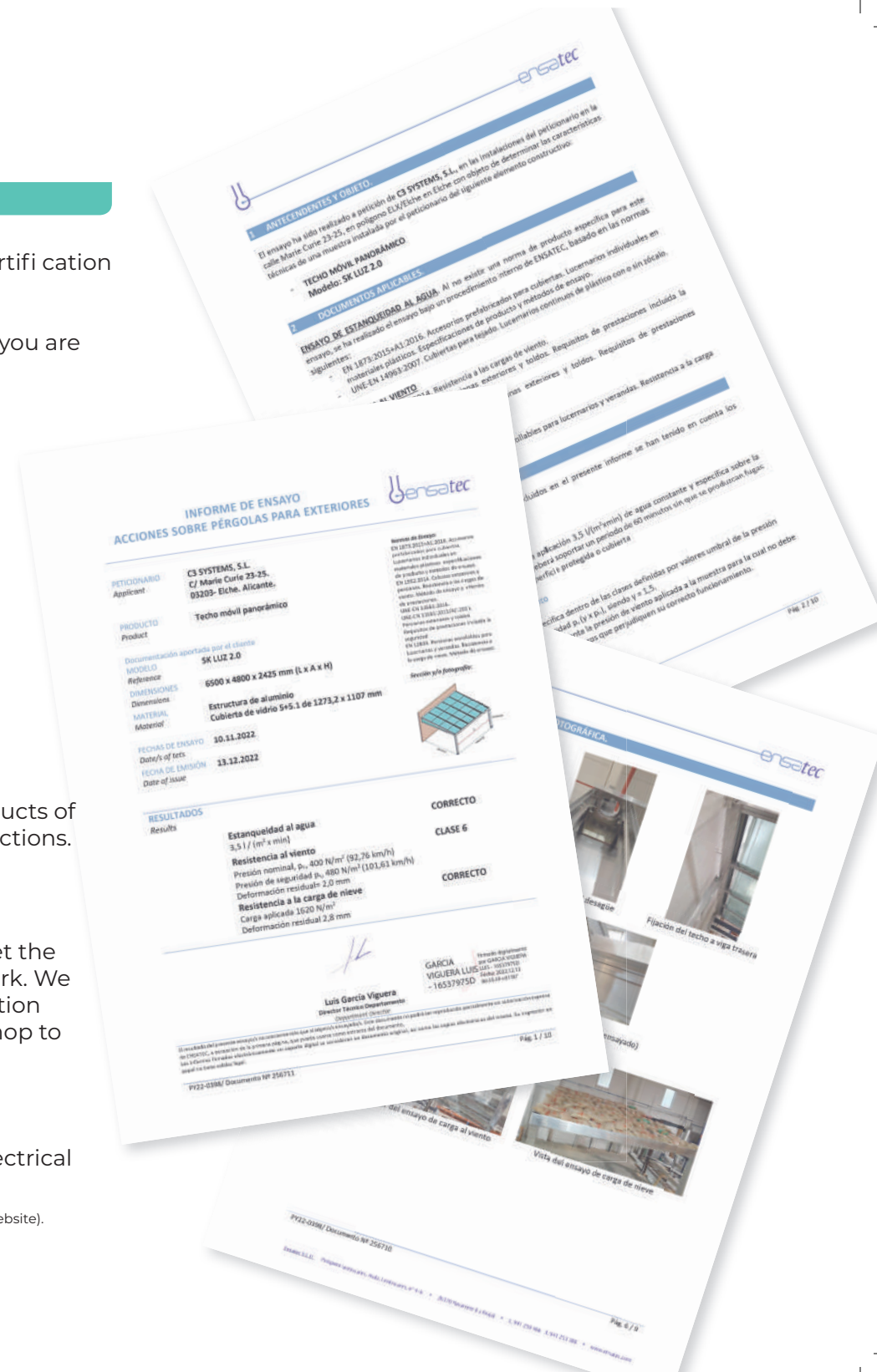





**“We create
spaces full
of light”**







CATÁLOGO



CATALOGO



KATALOG



C3 Systems, S.L. · C/ Ibi, 13 · Polígono Industrial Cachapets
03330 Crevillente (Alicante) España
Telf. +34 966 286 186
c3systems@c3systems.es · www.c3systems.es

MADE IN SPAIN



ED. 1 - 2023

The purpose of this document is for commercial purpose. It does not constitute an authentic advertising offer in "strict sense". For the official offer, please contact C3 Systems S.L. in order to receive specific and personalized information that contains objective information regarding relevant characteristics which means that it will constitute an offer in a "strict sense".

C3 Systems S.L. commits not to make misleading advertising by this means. To these effects, therefore, formal or numerical errors that could be found in the content of this document are not considered as misleading advertising, in particular regarding to the image accompanying in an illustrative way, and not contractual. In any case C3 Systems S.L. commits to correct it as soon as it becomes aware of such errors.